

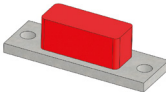

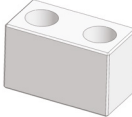









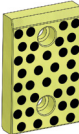

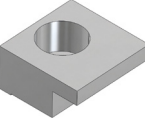

Die Components Normalien Componenti

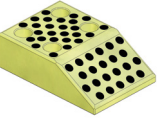
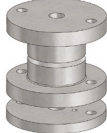

OMCR[®]
STANDARD DIE COMPONENTS

BCD 7247,314	BCD 7247,316	BCD 8265,411	BCD 8265,411	BCD 8271,812
				
Slide stop block Schieberranschlag Arresto slitta	Cam Buffer Anschlag Arresto	Balance block Distanzstück Distanziale	Balance block Distanzstück Distanziale	Lifting pin Tragbolzen mit fallringsicherung Perno di sollevamento
633	633	634	634	635
BCD 8271,862	BCD 8272,22	BCD 8272,22	BCD 8272,411	BCD 8272,411
				
Spacer blocks Distanzstück Distanziale	Wear plate Vdi 3357 Gleitplatte Vdi 3357 Piastra guida Vdi 3357	Wear plate Vdi 3357 Gleitplatte Vdi 3357 Piastra guida Vdi 3357	Guide pillars Führungssäule Colonna	Guide post retainer with retainer ring Führungssäule mit sprengring Ritegno per colonna con anello di tenuta
636	637	638	639	640
BCD 8272,412	BCD 8272,421	BCD 8272,421	BCD 8272,677	BCD 8272,677
				
Guide post DIN 9833 Führungssäule DIN 9833 Colonna DIN 9833	Bush self-lubricating Führungsbuchse Boccola autolubrificante	Toe clamp Haltestück Ritegno per boccola	Cam dwell wear plate VDI 3357 Überlaufkeile VDI 3357 Cuneo VDI 3357	Cam dwell wear plate VDI 3357 Überlaufkeile VDI 3357 Cuneo VDI 3357
641	642	642	643	644
BCD 8272,841	BCD 8272,852	BCD 8272,6729	BCD 8272,6749	BCD 8272,6759
				
Locating cone Kegeldistanz Cono di centraggio	Locating pin Zentrierbolzen Perno di centraggio	Guide bar VDI 3357 Führungsleiste VDI 3357 Lardone VDI 3357	Angular guide Winkelleiste Guida angolare	"V" driver VDI 3357 Prismenführung VDI 3357 Guida A "V" VDI 3357
645	646	646	647	648

BCD 8272,6759	BCD 8272,6759	BCD 8272,6759	BCD 8272,6759	BCD 8272,6759
"V" driver VDI 3357 Prismenführung VDI 3357 Guida A "V" VDI 3357	"V" driver with positive return Prismenführung mit Zwangsrückholer Guida a "V" con gancio Di Ritorno	"V" driver Prismenführung Guida a "V"	"V" driver Prismenführung Guida a "V"	"V" driver Prismenführung Guida a "V"
648	649	649	650	650
BCD 8272,6759	BCD 8272,6759	BCD 8272,6759	BCD 8272,6759	BCD 8272,6759
"V" driver Prismenführung Guida a "V"	Adjustment plate lower Justierplatte unten Piastra di registrazione inferiore	Adjustment plate front Justierplatte vorne Piastra di registrazione frontale	Adjustment plate front Justierplatte vorne Piastra di registrazione frontale	Adjustment plate rear Justierplatte hinten Piastra di registrazione posteriore
650	651	651	651	652
BCD 8272,6759	BCD 8272,6759	BCD 8283,133	BCD 8283,133	BCD 8283,134
Adjustment plate rear Justierplatte hinten Piastra di registrazione posteriore	Positive return Zwangsrückholer Gancio	Support for sensor Lagekontrolle für platinen Supporto sensore	Gage for sensor Einweiser für teillagekontrolle Riferimento per sensore	Gage hardened Einweiser gehärtet Riferimento indurito
652	652	653	653	654
BCD 8284,67	BCD 8284,83	BCD 8284,83	BCD 8284,83	BCD 8284,86
Stripper for blanking dies Abstreifer für platinenschnitte Estrattore per stampi	Pad retainer pin VDI 3365 Steckbolzen VDI 3365 Perno di arresto VDI 3365	Lock washer Sicherungsscheibe Piastrina di sicurezza	Shock absorber Halteelement Ammortizzatore	Elastomer washer Dämpfungsscheibe Ammortizzatore
654	655	655	656	656

BCD 8284,92	BCD 8284,92
	
<p>Ground collar screw Schraube mit distanzrohr Vite con colletto</p>	<p>Buffer Stossdämpfer Ammortizzatore</p>
<p>657</p>	<p>657</p>

SLIDE STOP BLOCK - SCHIEBERRANSCHLAG - ARRESTO SLITTA

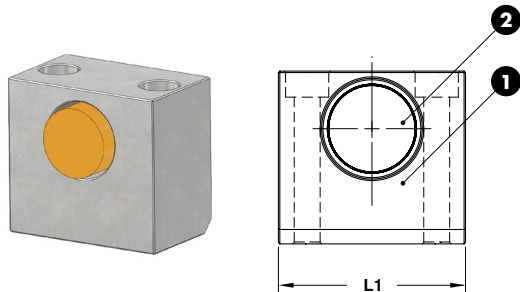

Notes

- 1 Material:** CK45
- 2 Material:** Elastomer 90 SH

STOCK ...

ORDER EXAMPLE 	VOLVO CODE
	6600014062

VOLVO CODE	L1
6600014061	65
6600014062	75

Standard Volvo

CAM BUFFER - ANSCHLAG - ARRESTO

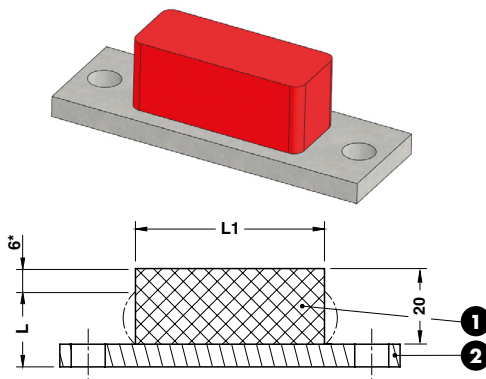

Notes

- 1 Material:** Polyurethane 90 SH
- 2 Material:** Si37

STOCK ...

*Max. deflection
Max. zul. Federweg
Deflessione massima

**Gegenkraft bei 6mm max. zul. Federweg
Max. reaction force with 6 mm deflection
Forza di reazione massima per deflessione di 6mm

***Maximal absorbierte Energie bei 6 mm max. zul. Federweg
Massima energia assorbita con deflessione di 6 mm

ORDER EXAMPLE 	VOLVO CODE
	9909206

VOLVO CODE	L1	Force for length "L" (kN)**	Max energy absorbtion with 6 mm deflection (J)***
9909205	50	10	30
9909206	100	20	60

BALANCE BLOCK - DISTANZSTÜCK - DISTANZIALE

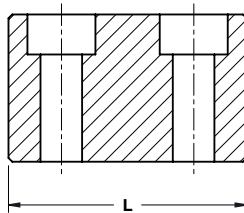
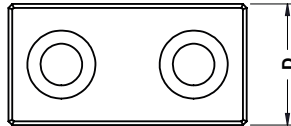
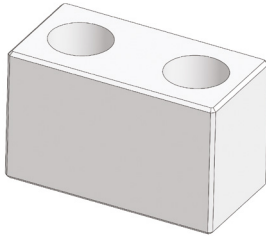

Notes

Material: CK45



	VOLVO CODE	H=100
	39927347	100
VOLVO CODE		D
39927346		32
39927347		40
		L
		63
		80

BALANCE BLOCK - DISTANZSTÜCK - DISTANZIALE

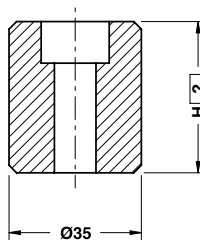

Notes

Material: CK45



	VOLVO CODE	H=100
	9917782	100
VOLVO CODE		D
39927348		65
9917782		35

LIFTING PIN - TRAGBOLZEN MIT FALLRINGSICHERUNG - PERNO DI SOLLEVAMENTO



Respect the max load
Maximale Nutzlast beachten
Rispettare il carico Max

WARNING - ACHTUNG - ATTENZIONE:

For safety reason, please consider always that the weight of the die has to be supported by just 2 lifting pins.

Aus Sicherheitsgründen stets berücksichtigen, dass zwei Tragbolzen das gesamte Werkzeuggewicht tragen müssen.

Per ragioni di sicurezza, considerare sempre che il peso dello stampo deve essere sopportato da 2 soli perni.

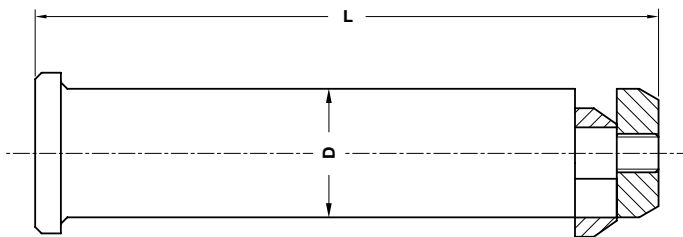
Notes**Material:** St52

	VOLVO CODE
	39919041

VOLVO CODE	Max load (kg)	Max die weight (kg)	D	L
39919040	2500	5000	40	195
39919041	8000	16000	63	285
39919042	12000	24000	63	327
39919043	20000	40000	80	402

SPACER BLOCK - DISTANZSTÜCK - DISTANZIALE

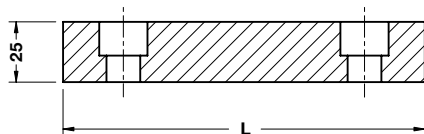
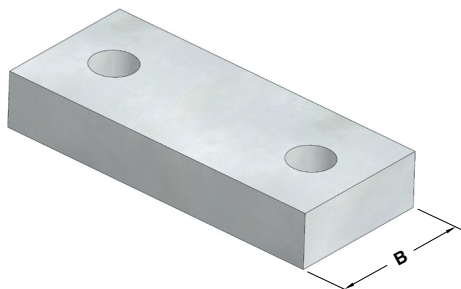

Notes

Material: CK45

STOCK

ORDER EXAMPLE	VOLVO CODE		
	39925954		
VOLVO CODE	B	L	Max Load (t)
39925953	63,5	150	250
39925954	40,5	100	90

WEAR PLATE STEEL VDI 3357
GLEITPLATTE STAHL VDI 3357
PIASTRA GUIDA IN ACCIAIO VDI 3357

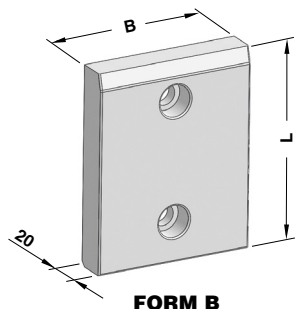

FORM B

Notes
Material: 16MnCr5 - HRC 58±60

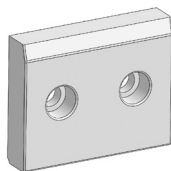

FORM D

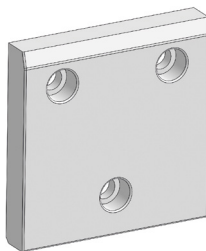

FORM G

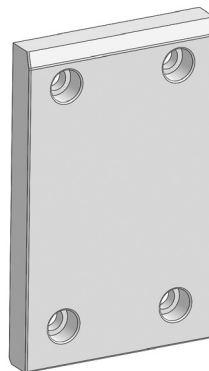

FORM H

	VOLVO CODE
	6303053663

VOLVO CODE	B	L	FORM	VOLVO CODE	B	L	FORM
6303053662	50	160	B	6303052289	100	315	B
6303053663	50	200	B	6303052290	125	100	G
6303052279	80	100	B	6303052291	125	160	G
6303052280	80	160	B	6303052292	125	200	G
6303052281	80	200	B	6303052293	125	250	G
6303052282	80	250	B	6303052294	125	315	G
6303052283	80	315	B	6303052295	160	100	G
6303052284	100	50	D	6303052296	160	160	G
6303052285	100	100	B	6303052297	160	200	G
6303052286	100	160	B	6303052298	160	250	H
6303052287	100	200	B	6303052299	160	315	H
6303052288	100	250	B				

Standard Volvo

**WEAR PLATE SELF-LUBRICATING VDI 3357
GLEITPLATTE BRONZE MIT FESTSCHMIERSTOFF VDI 3357
PIASTRA GUIDA AUTOLUBRIFICANTE VDI 3357**

Notes

Material: Bronze + Graphite

HB > 190

STOCK

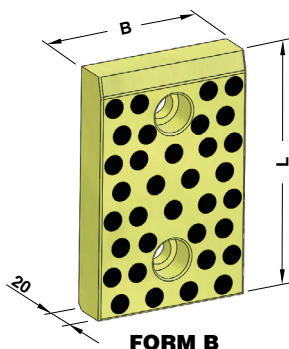

FORM B

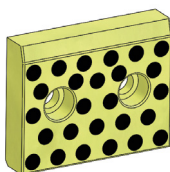

FORM D

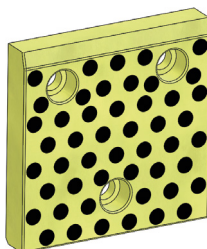

FORM G



FORM H



VOLVO CODE

6303053665

VOLVO CODE	B	L	FORM	VOLVO CODE	B	L	FORM
6303053664	50	160	B	6303052310	100	315	B
6303053665	50	200	B	6303052311	125	100	G
6303052300	80	100	B	6303052312	125	160	G
6303052301	80	160	B	6303052313	125	200	G
6303052302	80	200	B	6303052314	125	250	G
6303052303	80	250	B	6303052315	125	315	G
6303052304	80	315	B	6303052316	160	100	G
6303052305	100	50	D	6303052317	160	160	G
6303052306	100	100	B	6303052318	160	200	G
6303052307	100	160	B	6303052319	160	250	H
6303052308	100	200	B	6303052320	160	315	H
6303052309	100	250	B				

GUIDE POST - FÜHRUNGSSÄULE - COLONNA

Notes

1 Material: 16MnCr5 - HRC: 60÷62

2 3053052/3053058

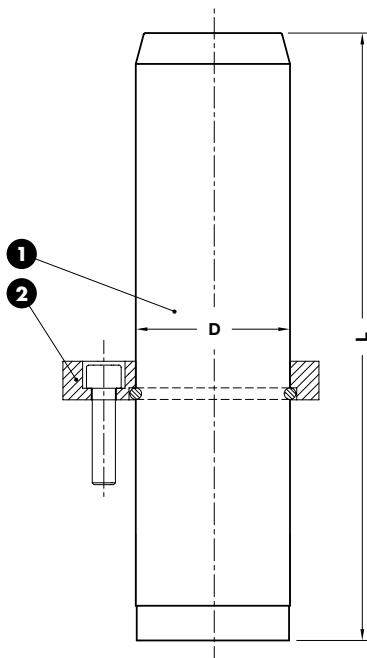
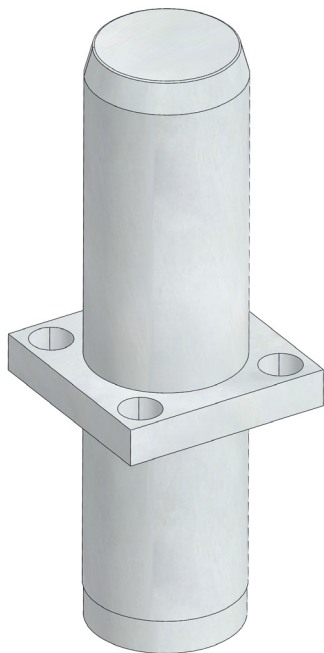

Standard Volvo

	VOLVO CODE
	6303053018

VOLVO CODE	D	L	VOLVO CODE	D	L	VOLVO CODE	D	L
6303053017	25	140	6303053027	40	250	6303053041	63	400
6303053018	25	160	6303053030	50	200	6303053044	80	315
6303053019	25	180	6303053031	50	220	6303053045	80	355
6303053020	32	140	6303053032	50	250	6303053046	80	400
6303053021	32	160	6303053033	50	280	6303053047	80	500
6303053022	32	180	6303053034	50	315	6303053049	100	355
6303053023	32	200	6303053037	63	250	6303053050	100	400
6303053024	40	180	6303053038	63	280	6303053051	100	500
6303053025	40	200	6303053039	63	315			
6303053026	40	220	6303053040	63	355			

GUIDE POST RETAINER WITH RETAINER RING
FÜHRUNGSSÄULE MIT SPRENGRING
RITEGNO PER COLONNA CON ANELLO DI TENUTA

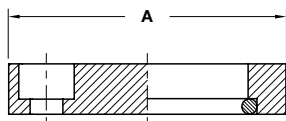
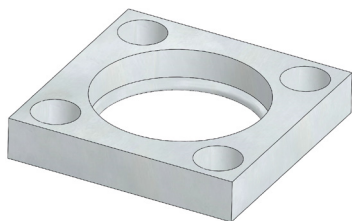

Notes

Material: CK45

stock

Application Example

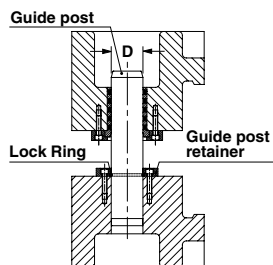

ORDER
EXAMPLE

VOLVO CODE

6303053053

VOLVO CODE	A	D (guide post)
6303053052	45	25
6303053053	56	32
6303053054	70	40
6303053055	80	50
6303053056	100	63
6303053057	110	80
6303053058	140	100

GUIDE POST DIN 9833 - FÜHRUNGSSÄULE DIN 9833 - COLONNA DIN 9833

Notes

Material: 16MnCr5 - **HRC:** 60±62

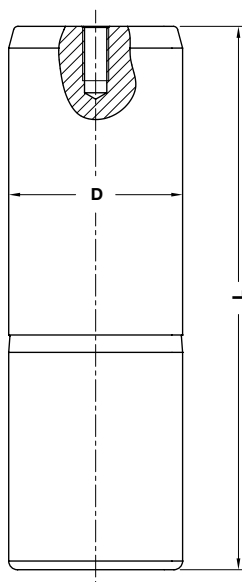

Standard Volvo

	VOLVO CODE
	6303051001

VOLVO CODE	D	L	VOLVO CODE	D	L	VOLVO CODE	D	L
6303053374	25	140	6303051009	50	200	6303051017	80	315
6303051001	25	160	6303051010	50	224	6303053388	80	355
6303053375	25	180	6303053381	50	250	6303051018	80	400
6303053376	32	140	6303051011	50	280	6303053389	100	315
6303051003	32	160	6303053382	50	315	6303053390	100	355
6303051004	32	180	6303053383	63	200	6303051020	100	400
6303051005	32	200	6303053384	63	224	6303051022	100	500
6303053377	40	160	6303051013	63	250	6303051023	125	400
6303051006	40	180	6303053385	63	280	6303051024	125	450
6303051007	40	200	6303051014	63	315	6303051025	125	500
6303053378	40	224	6303051015	63	355	6303051026	160	400
6303051008	40	250	6303051016	63	400	6303051027	160	450
6303053379	50	160	6303053386	80	250	6303051028	160	500
6303053380	50	180	6303053387	80	280			

BUSH SELF-LUBRICATING DIN 9834
FÜHRUNGSBUCHSE DIN 9834
BOCCOLA AUTOLUBRIFICANTE DIN 9834

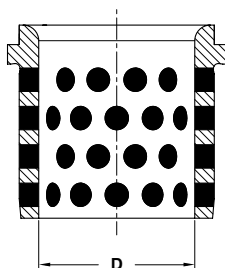

STOCK



Notes

Material: Bronze + Graphite
HB > 190

ORDER
EXAMPLE

VOLVO CODE

6303051059

VOLVO CODE

D

6303051058

25

6303051059

32

6303051060

40

6303051061

50

6303051062

63

6303051063

80

6303051064

100

6303051065

125

6303051066

160

TOE CLAMP - HALTESTÜCK - RITEGNO PER BOCCOLA

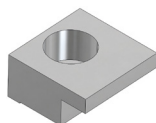

Notes

Material: CK45

Application example

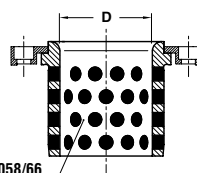

3051058/66

STOCK

ORDER
EXAMPLE

VOLVO CODE

6303053618

VOLVO CODE

D

6303053617

25-50

6303053618

63-160

**CAM DWELL WEAR PLATE STEEL VDI 3357
 UBERLAUFKEILE STAHL VDI 3357
 CUNEO IN ACCIAIO VDI 3357**

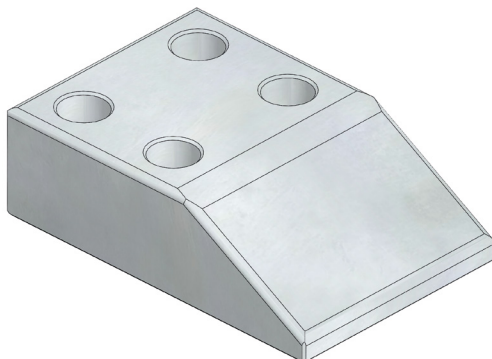

Notes
Material: 42CrMo4
HRC: 58÷60

stock

Standard Volvo

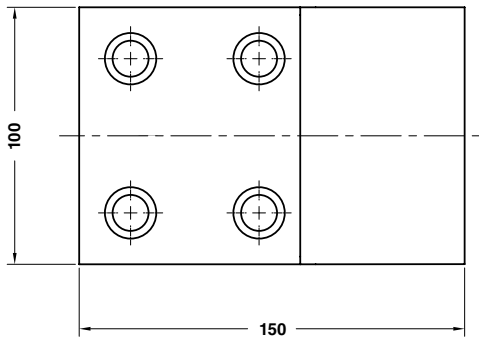
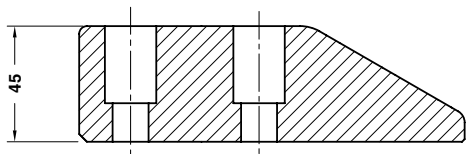

	VOLVO CODE
	3053061
VOLVO CODE	
3053061	

**CAM DWELL WEAR PLATE SELF-LUBRICATING VDI 3357
 UBERLAUFKEILE BRONZE MIT FESTSCHMIERSTOFF VDI 3357
 CUNEO AUTOLUBRIFICANTE VDI 3357**

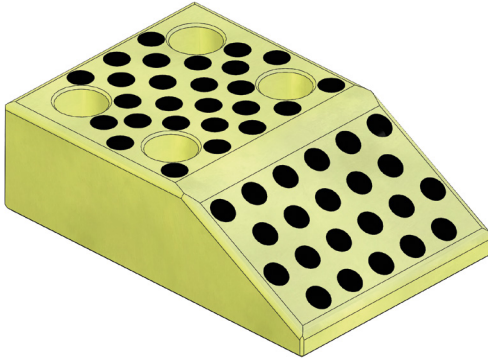

Notes
Material: Bronze + Graphite
HB > 190

STOCK

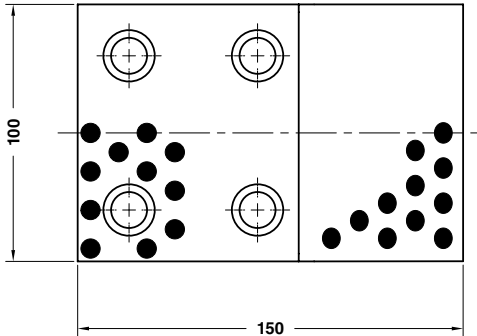
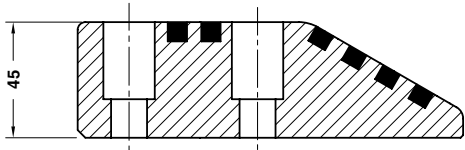

	VOLVO CODE
	3053062
VOLVO CODE	
3053062	

LOCATING CONE - KEGELDISTANZ - CONO DI CENTRAGGIO

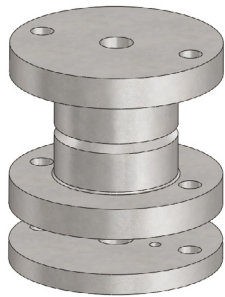

FORM A

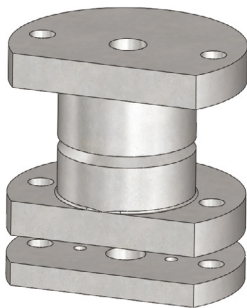

FORM B

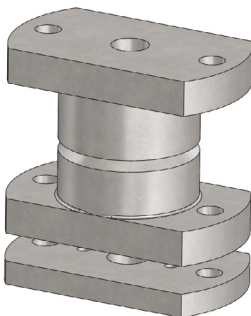

FORM C

Notes

1 2 Material: 16MnCr5
HRC: 58÷60

3 Material: CK45

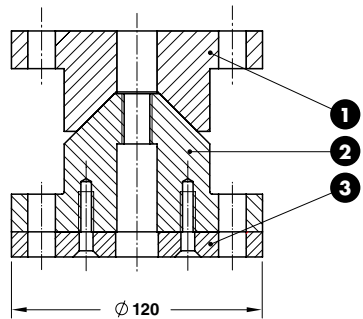

Standard Volvo

	VOLVO CODE
	3054831
VOLVO CODE	FORM
3054830	A
3054831	B
3051349	C

LOCATING PIN - ZENTRIERBOLZEN - PERNO DI CENTRAGGIO

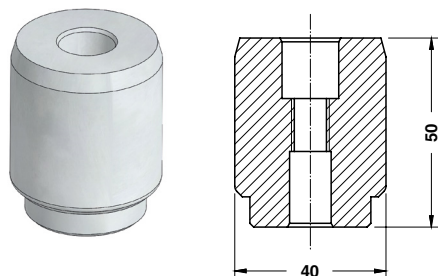

Notes

Material: 16MnCr5 - **HRC:** 60÷62

STOCK

	VOLVO CODE
	9910244
VOLVO CODE	
9910244	

GUIDE BAR VDI 3357 - FÜHRUNGSLEISTE VDI 3357 - LARDONE VDI 3357

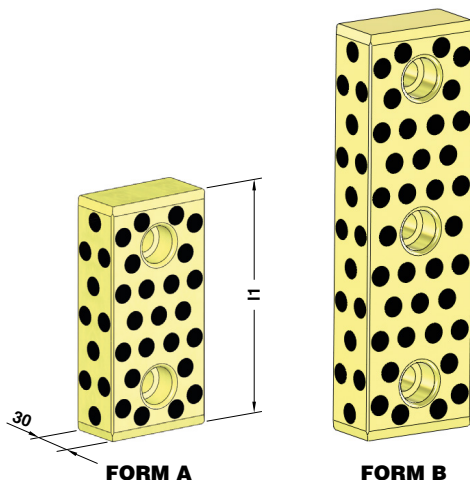

Notes

Material: Bronze + Graphite - **HB** >190

STOCK



	VOLVO CODE	
	3052827	
VOLVO CODE	l1	FORM
3052826	150	A
3052827	200	B

ANGULAR GUIDE - WINKELLEISTE - GUIDA ANGOLARE

Notes

Material: Bronze + Graphite - **HB >190**

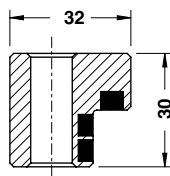
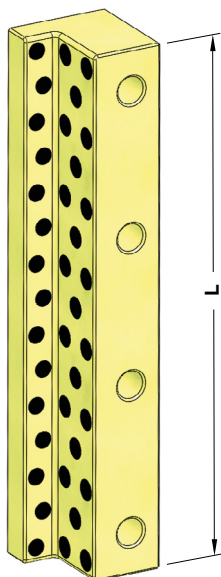

FORM A

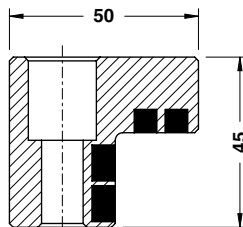

FORM B

Standard Volvo

	VOLVO CODE	
	3052834	
VOLVO CODE	FORM	L
3052833	A	150
3052834	A	200
3052835	B	200
3052836	B	250

"V" DRIVER VDI 3357 - PRISMENFÜHRUNG VDI 3357 - GUIDA A "V" VDI 3357

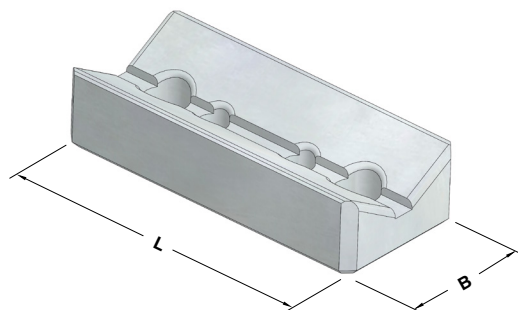

Notes

Material: CK45 - HRC: 58÷60

STOCK



VOLVO CODE

6303052819

VOLVO CODE	B	L
6303052818	65	150
6303052819	65	200
6303052820	125	150
6303052821	125	200

"V" DRIVER VDI 3357 - PRISMENFÜHRUNG VDI 3357 - GUIDA A "V" VDI 3357

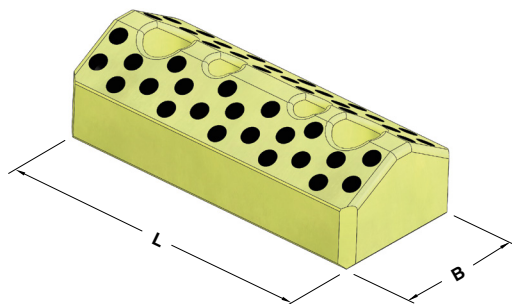

Notes

Material: Bronze + Graphite - HB >190

STOCK



VOLVO CODE

6303052823

VOLVO CODE	B	L
6303052822	65	150
6303052823	65	200
6303052824	125	150
6303052825	125	200

**"V" DRIVER WITH POSITIVE RETURN
PRISMENFÜHRUNG MIT ZWANGSRÜCKHOLER
GUIDA A "V" CON GANCIO DI RITORNO**

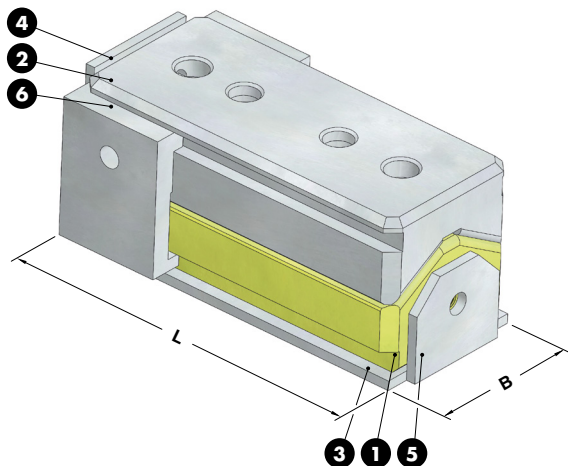

Notes

- ❶ 39925989÷92
- ❷ 39925993÷96
- ❸ 39925997÷39926000
- ❹ 39926003÷39926004
- ❺ 39926001÷39926002
- ❻ 39926005



VOLVO CODE
6339925986

VOLVO CODE	B	L
6339925985	65	150
6339925986	65	200
6339925987	125	150
6339925988	125	200

Standard Volvo

"V" DRIVER - PRISMENFÜHRUNG - GUIDA A "V"

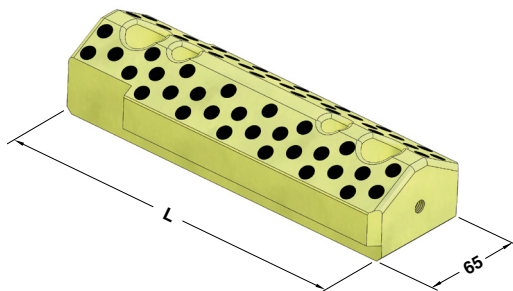

Notes

Material: Bronze + Graphite - HB >190



VOLVO CODE
6339925990

VOLVO CODE	L
6339925989	150
6339925990	200

"V" DRIVER - PRISMENFÜHRUNG - GUIDA A "V"

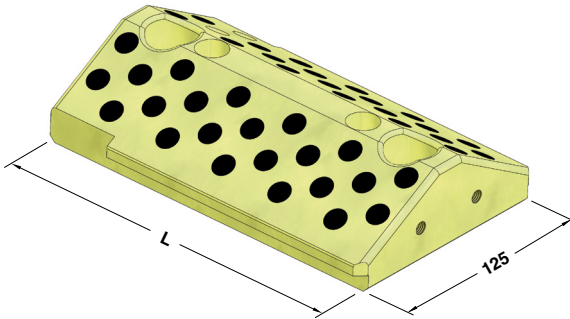

Notes

Material: Bronze + Graphite - HB >190



VOLVO CODE
6339925992

VOLVO CODE	L
6339925991	150
6339925992	200

"V" DRIVER - PRISMENFÜHRUNG - GUIDA A "V"

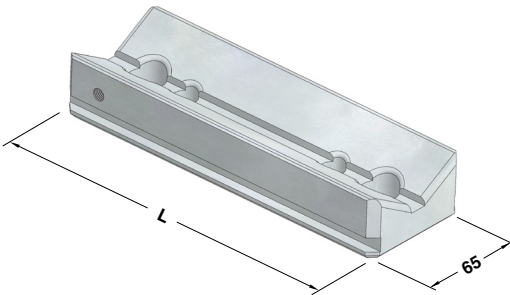

Notes

Material: CK45 - HRC: 58÷60



VOLVO CODE
6339925994

VOLVO CODE	L
6339925993	150
6339925994	200

"V" DRIVER - PRISMENFÜHRUNG - GUIDA A "V"

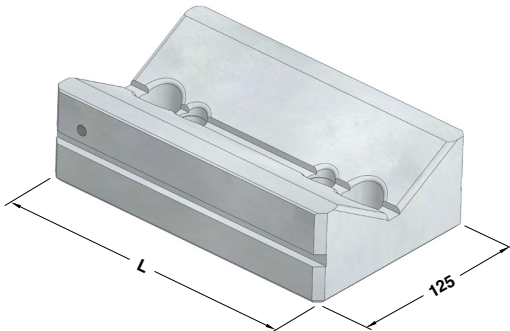

Notes

Material: CK45 - HRC: 58÷60



VOLVO CODE
6339925996

VOLVO CODE	L
6339925995	150
6339925996	200

ADJUSTMENT PLATE LOWER - JUSTIERPLATTE UNTEN - PIASTRA DI REGISTRAZIONE INFERIORE

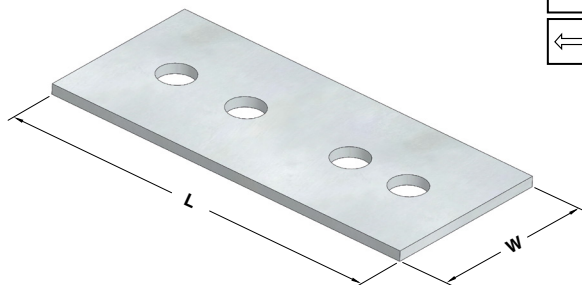

STOCK

Notes



Material: S355JR



VOLVO CODE

6339925998

VOLVO CODE	W	L
6339925997	65	150
6339925998	65	200
6339925999	125	150
6339926000	125	200

ADJUSTMENT PLATE FRONT - JUSTIERPLATTE VORNE - PIASTRA DI REGISTRAZIONE FRONTALE

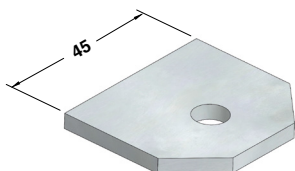

Notes

Material: S355JR

STOCK



VOLVO CODE

6339926001

VOLVO CODE

6339926001

ADJUSTMENT PLATE FRONT - JUSTIERPLATTE VORNE - PIASTRA DI REGISTRAZIONE FRONTALE

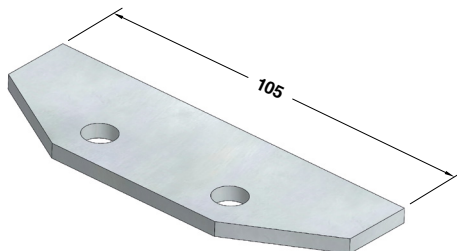

Notes

Material: S355JR

STOCK



VOLVO CODE

6339926002

VOLVO CODE

6339926002

ADJUSTMENT PLATE REAR - JUSTIERPLATTE HINTEN - PIASTRA DI REGISTRAZIONE POSTERIORE

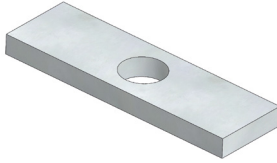

Notes

Material: S355JR

STOCK



VOLVO CODE

6339926003

VOLVO CODE

6339926003

ADJUSTMENT PLATE REAR - JUSTIERPLATTE HINTEN - PIASTRA DI REGISTRAZIONE POSTERIORE



Notes

Material: S355JR

STOCK



VOLVO CODE

6339926004

VOLVO CODE

6339926004

POSITIVE RETURN - ZWANGSRÜCKHOLER - GANCIO

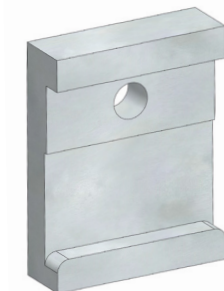

Notes

Material: 34CrNiMo6

STOCK



VOLVO CODE

6339926005

VOLVO CODE

6339926005

SUPPORT FOR SENSOR - LAGEKONTROLLE FÜR PLATINEN - SUPPORTO SENSORE

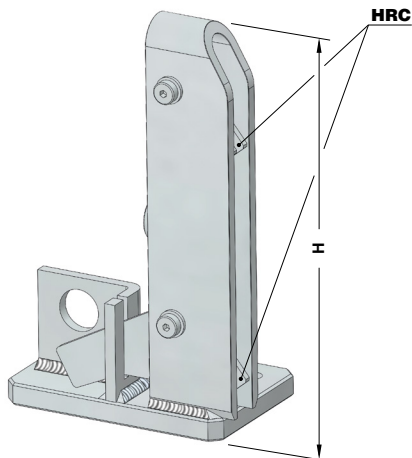

Notes

Material: Steel - **HRC:** 58÷60

STOCK

* As shown in drawing
Gemäß zeichnung
Come a disegno

** Opposite to drawing
Spiegelverkehrt
Opposto al disegno



VOLVO CODE

6305935476

VOLVO CODE	H	SIDE
6305935475	145	LEFT**
6305935476	145	RIGHT*
6305935477	185	LEFT**
6305935478	185	RIGHT*

GAGE FOR SENSOR - EINWEISER FÜR TEILLAGEKONTROLLE - RIFERIMENTO PER SENSORE

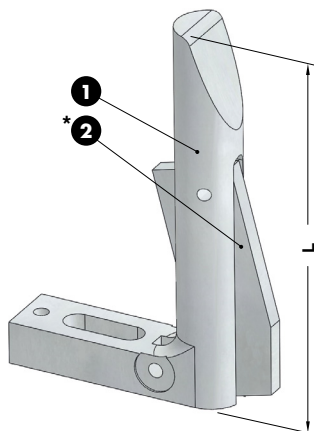

Notes

1 **Material:** CK60

2 **Material:** Si37 **HRC:** 58÷60

STOCK



VOLVO CODE

6303051761

VOLVO CODE	L
6303051760*	120
6303051761*	150
6303051762	180
6303051763	250

* With short plate
Mit kurz platte
Con piastra corta

GAGE HARDENED - EINWEISER GEHÄRTET - RIFERIMENTO INDURITO

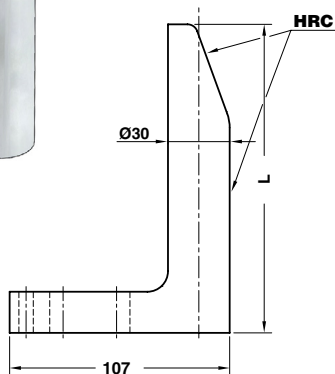
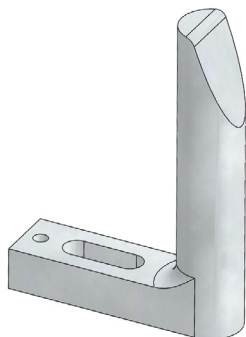

Notes

Material: CK60 - HRC: 58÷60

STOCK

ORDER
EXAMPLE

VOLVO CODE

3051755

VOLVO CODE

L

3051754

65

3051755

90

3051756

120

3051757

150

3051758

180

3051759

250

STRIPPER FOR BLANKING DIES - ABSTREIFER FÜR PLATINENSCHNITTE - ESTRATTORE PER STAMPI



Notes

Material: Elastomer 70SH

STOCK

ORDER
EXAMPLE

VOLVO CODE

6303042342

VOLVO CODE

6303042342

PAD RETAINER PIN - STECKBOLZEN - PERNO DI ARRESTO

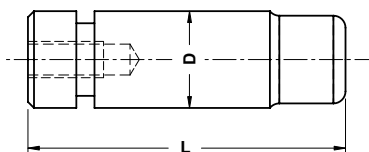
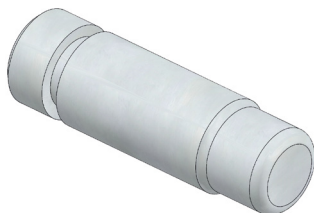

Notes

Material: 42CrMo4

STOCK



VOLVO CODE

9900734

VOLVO CODE	D	L
9900733	25	125
9900734	32	145
9900735	40	150
9900736	50	175
9900737	63	210

Standard Volvo

LOCK WASHER - SICHERUNGSSCHEIBE - PIASTRINA DI SICUREZZA

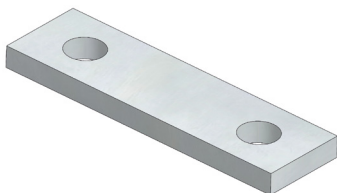

Notes

Material: S235JR

STOCK



VOLVO CODE

9900743

VOLVO CODE

9900743

SHOCK ABSORBER - HALTELEMENT - AMMORTIZZATORE

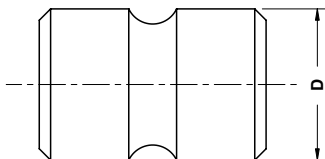

Notes

Material: CO-Polyester Elastomer

STOCK



VOLVO CODE

9934356

VOLVO CODE	D
9934355	40
9934356	50
5937181	63
9934367	80

ELASTOMER WASHER - DÄMPFUNGSSCHEIBE - AMMORTIZZATORE

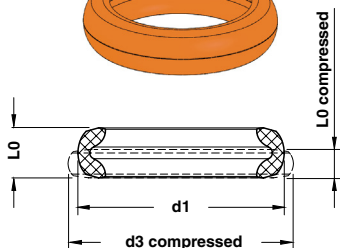
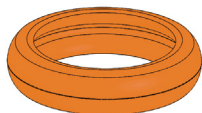

Notes

Material: CO-Polyester Elastomer

STOCK

*Die höchste Belastung
Carico massimo ammissibile

**Komprimiert
Compresso



VOLVO CODE

6305936830

VOLVO CODE	d1	d3 (compressed)**	L0	L0 (compressed)**	Shore	Load* (N)
6600017820	45,8	49,8	17,0	11,6	55D	20000
6305936830	54,6	61,8	21,3	13,0	55D	30000
6305937132	61,8	69,9	21,5	13,2	55D	46000
6305939451	78,2	89,0	29,8	17,9	55D	75000

GROUND COLLAR SCREW - SCHRAUBE MIT DISTANZROHR - VITE CON COLLETO

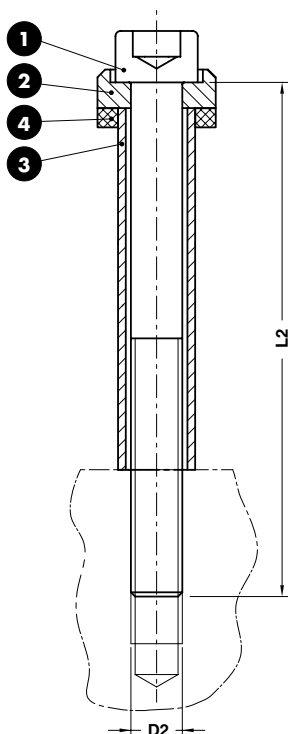

Notes

- 1 DIN 912 cl. 12.9
- 2 **Material:** Steel 1000 N/mm²
- 3 **Material:** Steel 1200÷1400 N/mm²
- 4 5935907÷5935910

STOCK

ORDER
EXAMPLEVOLVO CODE
6305935900

VOLVO CODE	D2	L2
6305935899	M8	80
6305935900	M10	90
6305935901	M10	100
6305935902	M10	110
6305939950	M12	100
6305939951	M12	120
6305939952	M12	140
6305939953	M12	180
6305939954	M16	130
6305939955	M16	140
6305939956	M16	150
6305939957	M16	160
6305939958	M16	180
6305939959	M16	200

BUFFER - STOSSDÄMPFER - AMMORTIZZATORE

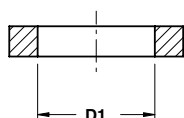

STOCK

Notes

Material: Elastomer 90 SHORDER
EXAMPLEVOLVO CODE
6305935908

VOLVO CODE	D1
6305935907	13
6305935908	15,5
6305935909	18
6305935910	26



OMCR
STANDARD DIE COMPONENTS

C 40 U
dynamic